

Andaime - Tubular

COMPONENTES, PEÇAS, DIMENSÕES E PESOS

Medidas em milímetros (mm) e pesos em quilos (kg)

PAINÉIS

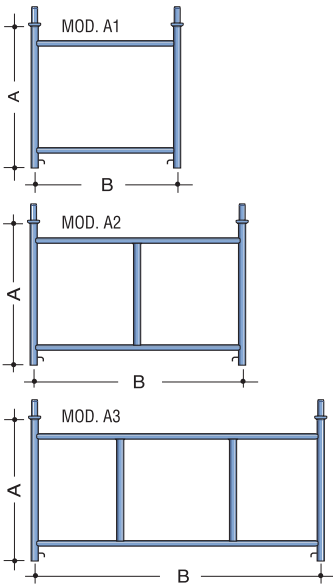

MOD.	A	B	PESO
A 1	1000	1037	10
A 2	1000	1535	12,5
A 3	1000	2030	15,2

SAPATAS E RODÍZIOS

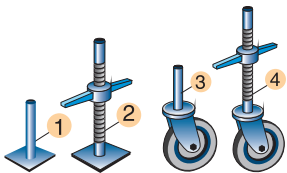

- 1 Sapata simples 3 Rodízio simples
2 Sapata ajustável 4 Rodízio ajustável

MOD.	ALT.	PESO	Ø RODÍZIO	AJUSTE
1	430	0,8	-	-
2	430	1,5	-	300
3	430	2,4	150	-
4	430	5	150	300

PISO METÁLICO

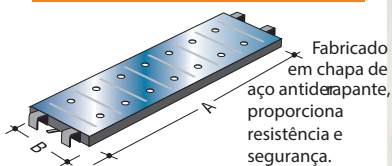

A	B	PESO
MEDIDAS PARA ANDAIMES DE 1000		
975	340	8
MEDIDAS PARA ANDAIMES DE 1500		
1475	370	11,6
MEDIDAS PARA ANDAIMES DE 2000		
1965	384	15,8

DIAGONAIS



MOD.	C	PESO
A 1	1475	2,2
A 2	2180	3,1
A 3	2880	3,8
A1 C/ A2	1850	3,5

BARRAS DE LIGAÇÃO

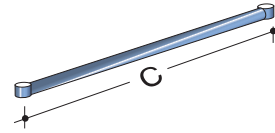

MOD.	C	PESO
A 1	1040	2,6
A 2	1540	3,9
A 3	2030	5,0

ESCADAS

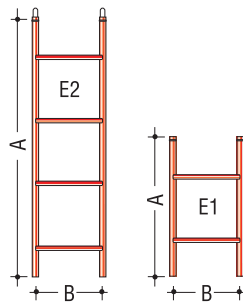

Este modelo de escada é padrão para todos os tamanhos de Andaimes

MOD.	A	B	PESO
E1	1000	430	13,3
E2	2000	430	6,4

GUARDA-CORPO

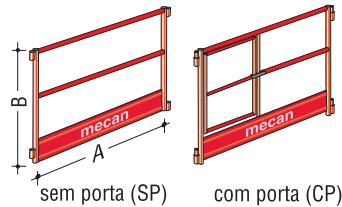

MOD.	A	B	PESO
SP 1x1	1037	1200	9,4
CP 1x1	1037	1200	16,8
SP 1,5x1,5	1535	1200	12,4
CP 1,5x1,5	1535	1200	19,8
SP 2x2	2030	1200	16,3
CP 2x2	2030	1200	22,4

MONTAGEM PADRÃO

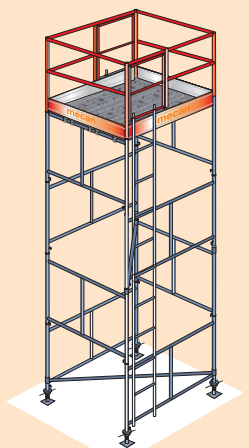
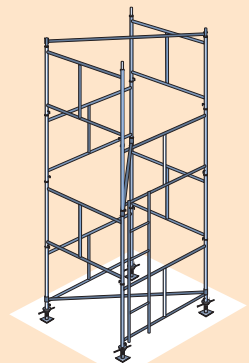
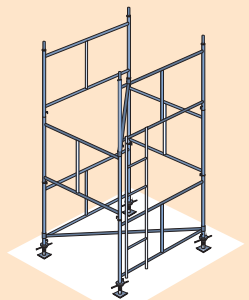
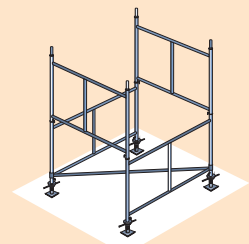
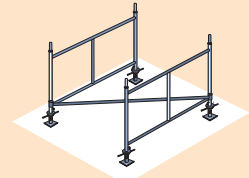

O Mecanfix atende às normas exigidas pela ABNT e NR18.